



Nothing but **HEAVY DUTY.**[®]



M18 FOPH-HTA

Original instructions

Originalbetriebsanleitung

Notice originale

Istruzioni originali

Manual original

Oorspronkelijke gebruiksaanwijzing

Original brugsanvisning

Original bruksanvisning

Bruksanvisning i original

Alkuperäiset ohjeet

Πρωτότυπο οδηγιών χρήσης

Orijinal işletme talimatı

Původním návodem k používání

Pôvodný návod na použitie

Instrukcja oryginalną

Eredeti használati utasítás

Izvirna navodila

Originalne pogonske upute

Instrukcijām oriģinālvalodā

Originalni instrukcija

Algupärane kasutusjuhend

Оригинальное руководство по эксплуатации

Оригинално ръководство за експлоатация

Instrucțiuni de folosire originale

Оригинален прирачник за работа

Оригінал інструкції з експлуатації

التعليمات الأصلية

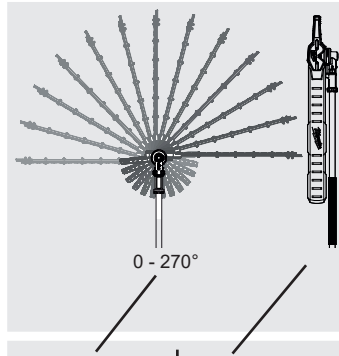
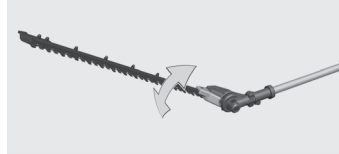
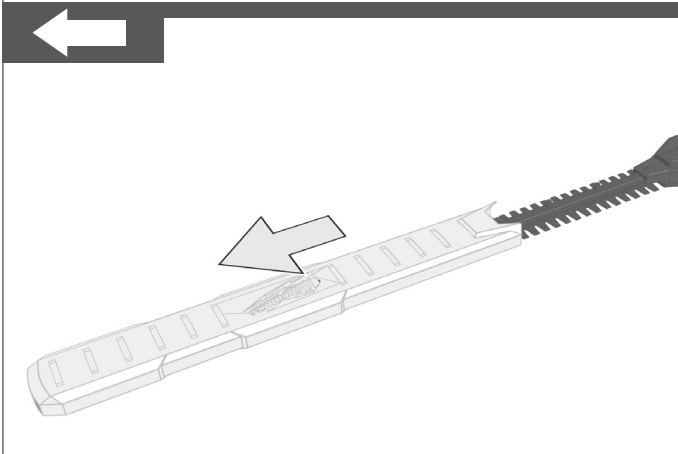
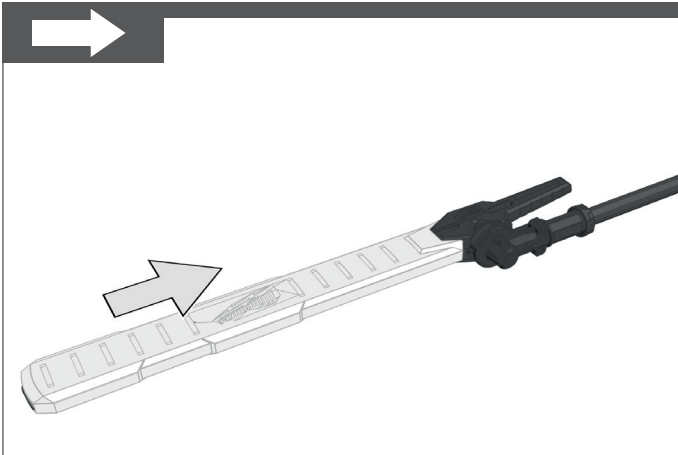
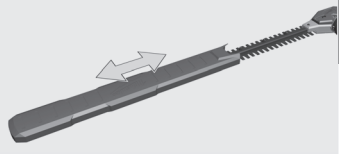

Trimming positions
 Schneidepositionen
 Trimming positions
 Schneidepositionen
 Trimming positions
 Schneidepositionen
 Trimming positions
 Schneidepositionen
 Trimming positions
 Schneidepositionen
 Trimming positions
 Schneidepositionen
 Trimming positions
 Schneidepositionen
 Trimming positions
 Schneidepositionen
 Trimming positions
 Schneidepositionen
 Trimming positions
 Schneidepositionen
 Trimming positions
 Schneidepositionen
 Trimming positions
 Schneidepositionen
 Trimming positions
 Schneidepositionen

Storage osition
 Lagerpositionen
 Storage osition
 Lagerpositionen
 Storage osition
 Lagerpositionen
 Storage osition
 Lagerpositionen
 Storage osition
 Lagerpositionen
 Storage osition
 Lagerpositionen
 Storage osition
 Lagerpositionen
 Storage osition
 Lagerpositionen
 Storage osition
 Lagerpositionen
 Storage osition
 Lagerpositionen
 Storage osition
 Lagerpositionen
 Storage osition
 Lagerpositionen
 Storage osition
 Lagerpositionen

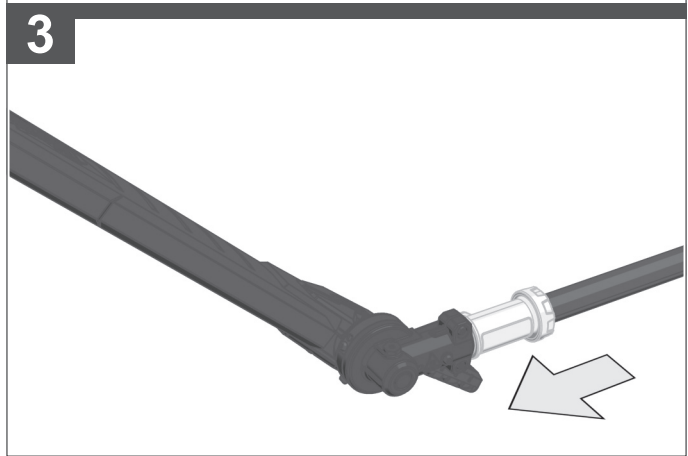
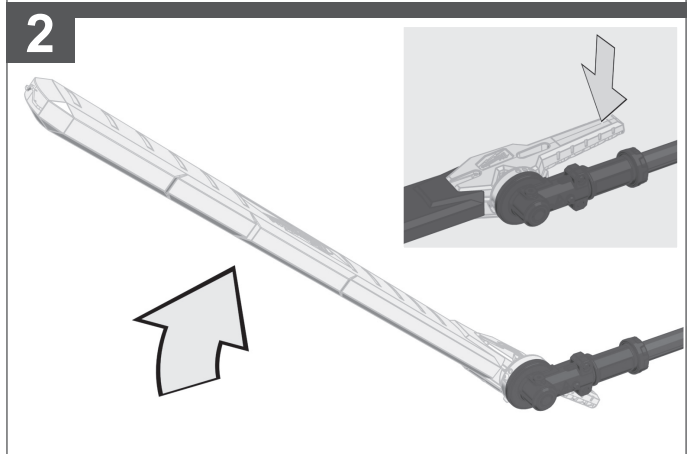
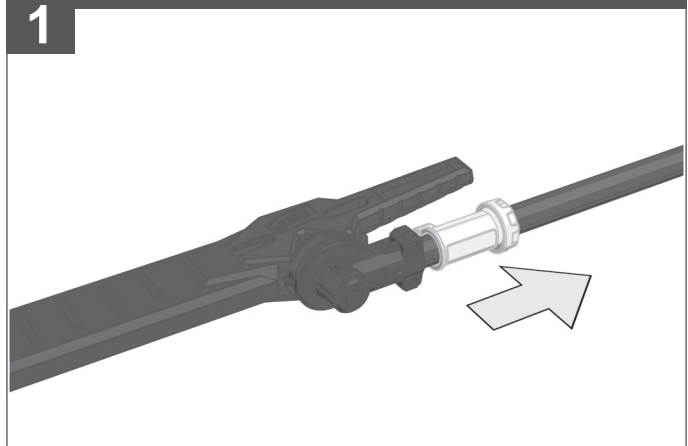

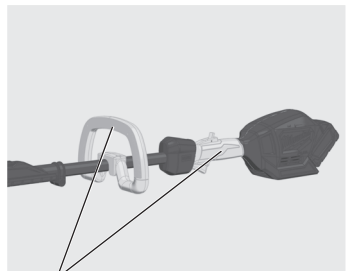
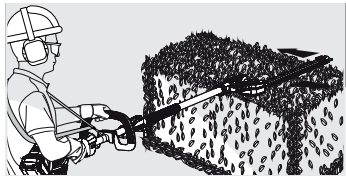

- Handle (insulated gripping surface)
- Handgriff (isolierte Grifffläche)
- Poignée (surface de prise isolée)
- Impugnatura (superficie di presa isolata)
- Empuñadura (superficie de agarre con aislamiento)
- Manípulo (superficie de pega isolada)
- Handgreep (geïsoleerd)
- Håndtag (isolerede gribeflader)
- Håndtak (isolert gripeflate)
- Handtag (isolerad greppyta)
- Kahva (eristetty tarttumapinta)
- Χειρολαβή (μονωμένη επιφάνεια λαβής)
- El kulpu (izolasyonlu tutma yüzeyi)
- Rukojeť (izolovaná uchopovací plocha)
- Rukováť (izolovaná úchopná plocha)
- Uchwyt (z izolowaną powierzchnią)
- Fogantyú (szigetelt fogófelület)
- Ročaj (izolirana prijemalna površina)
- Rukohvat (izolirana površina za držanje)
- Rokturis (izolēta satveršanas virsma)
- Rankena (izoliuotas rankenos paviršius)
- Käerpike (isoleeritud pideme piirkond)
- Рукятка (изолированная поверхность ручки)
- Ръкохватка (изолирана повърхност за хващане)
- Måner (suprafață de prindere izolată)
- Дршка (изолирана површина)
- Ручка (ізолювана поверхня ручки)

المقبض (مساحة المقبض معزولة)

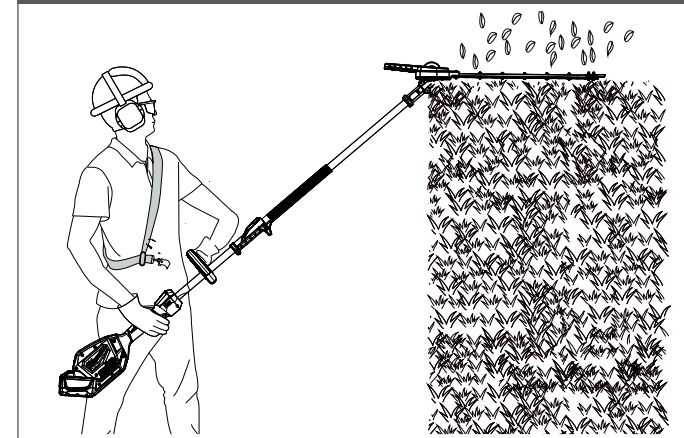
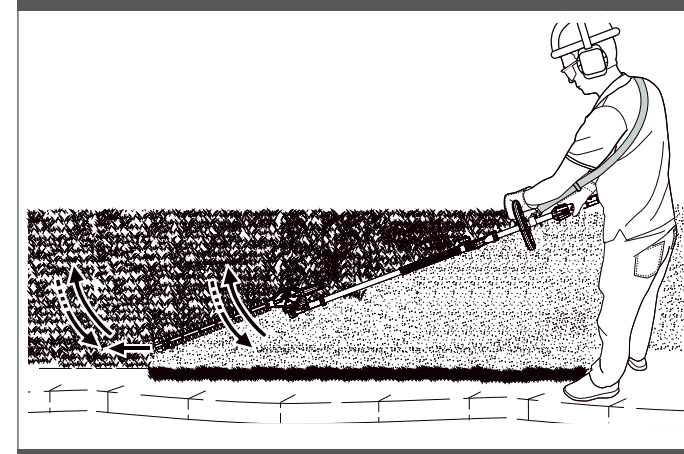
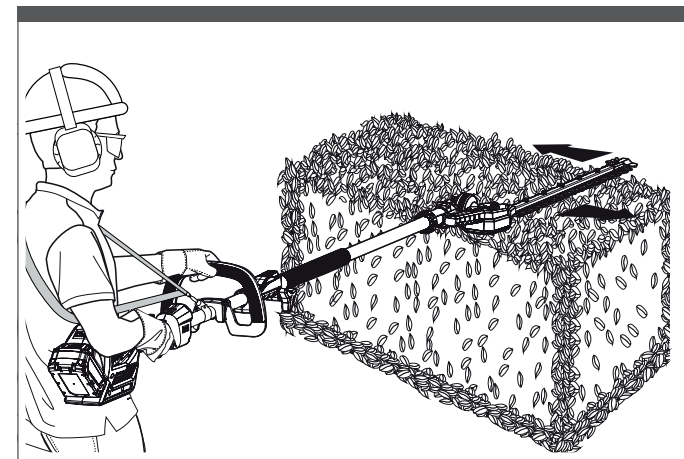
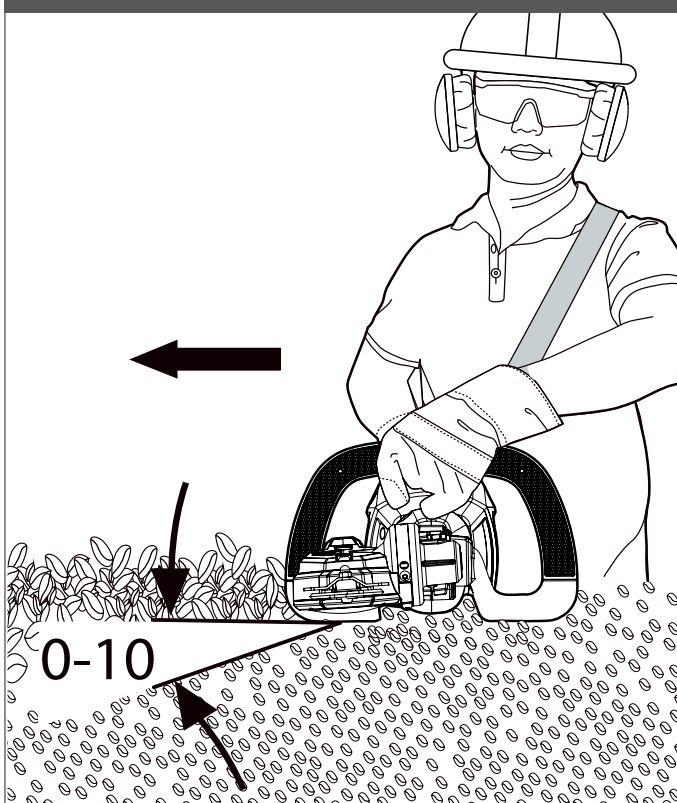
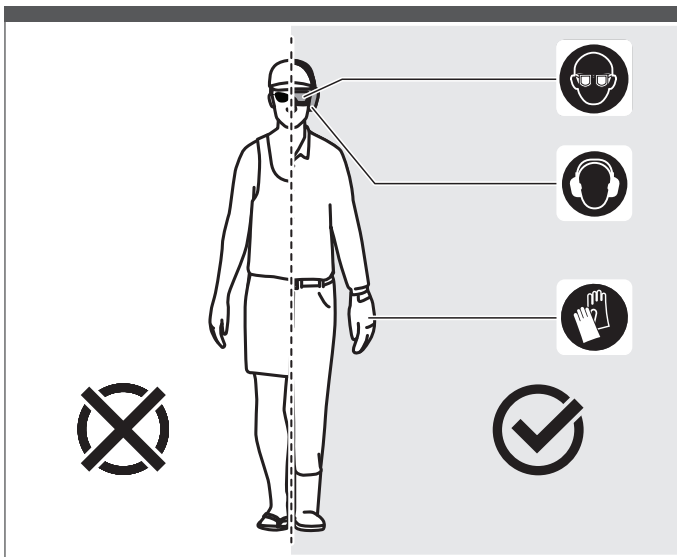

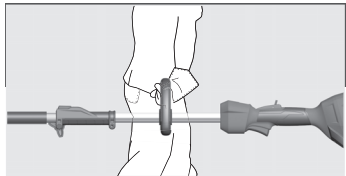

1

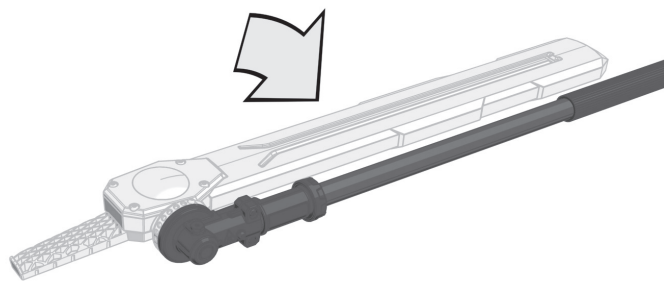

2

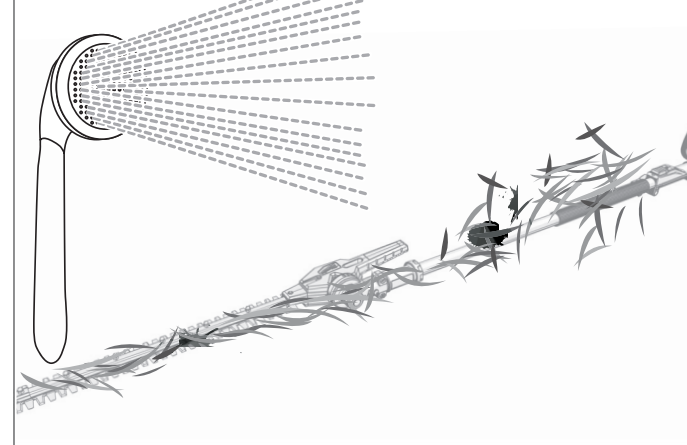
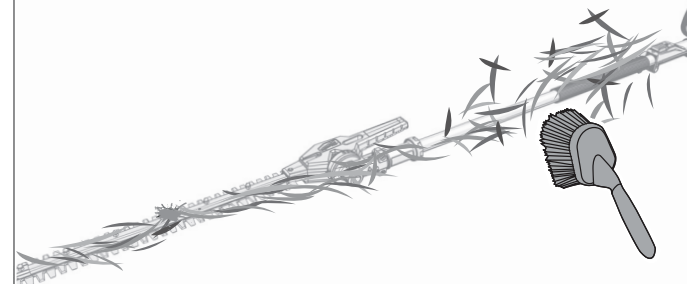
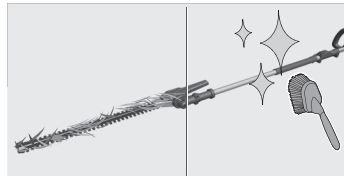
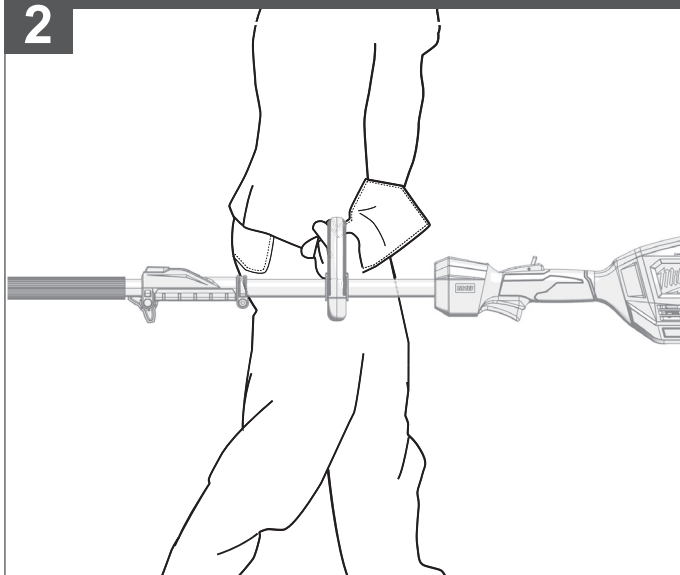

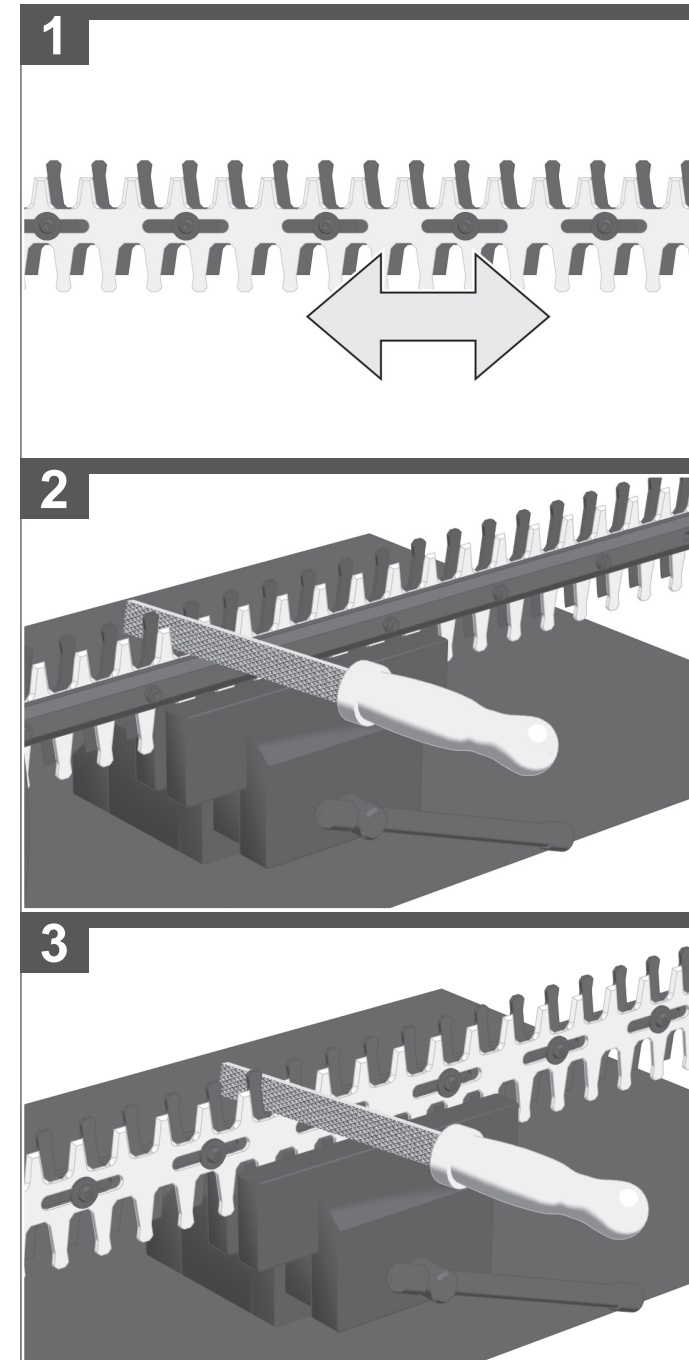
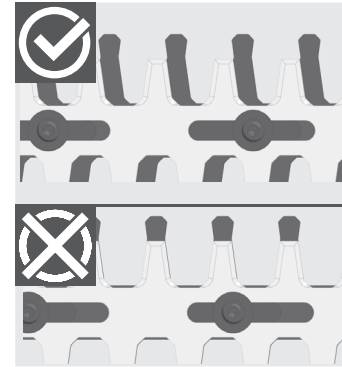
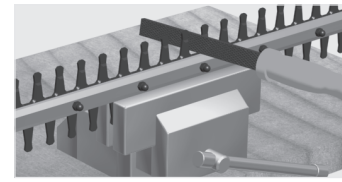
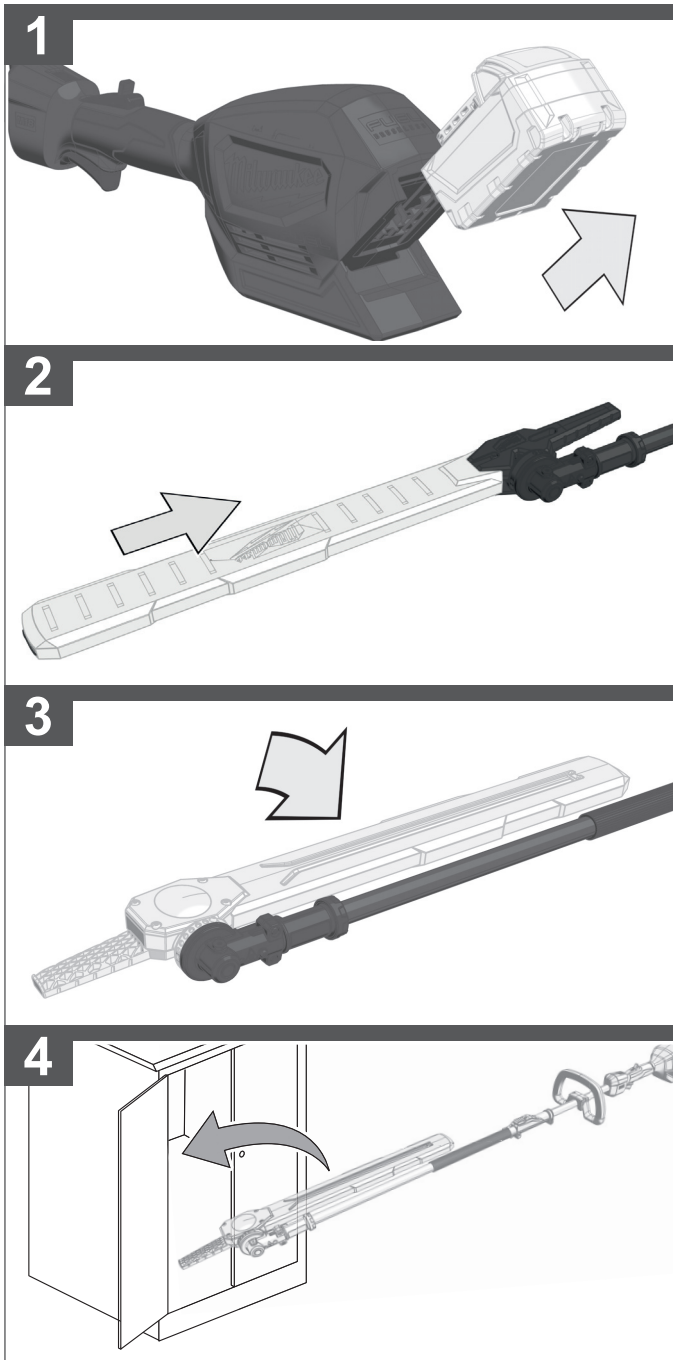
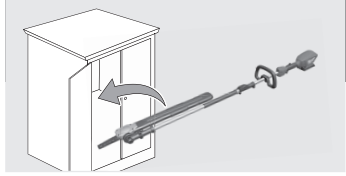

TECHNICAL DATA **CORDLESS HEDGE TRIMMER** **M18 FOPH-HTA**

Production code.....	4697 78 01...
	...000001-999999
No-load speed	0-3500 min ⁻¹
Blade length.....	609 mm
Tooth spacing	mm
Cutting capacity	19 mm
Sharpening angle to horizontal.....	
Weight according EPTA-Procedure 01/2014.....	kg

Vibration information
 Total vibration values (vector sum in the three axes) determined according to EN 60745.
 Vibration emission value a_v dB (A)
 Uncertainty K= dB (A)

For technical data and approvals of application heads for use on various powerbases please refer to the operating instructions of the used application head.

WARNING
 The vibration emission level given in this information sheet has been measured in accordance with a standardised test given in EN 60745 and may be used to compare one tool with another. It may be used for a preliminary assessment of exposure.

The declared vibration emission level represents the main applications of the tool. However if the tool is used for different applications, with different accessories or poorly maintained, the vibration emission may differ. This may significantly increase the exposure level over the total working period.

An estimation of the level of exposure to vibration should also take into account the times when the tool is switched off or when it is running but not actually doing the job. This may significantly reduce the exposure level over the total working period.

Identify additional safety measures to protect the operator from the effects of vibration such as: maintain the tool and the accessories, keep the hands warm, organisation of work patterns.

⚠ WARNING Read all safety warnings, instructions, illustrations and specifications provided with this power tool. Failure to follow all instructions listed below may result in electric shock, fire and/or serious injury.
Save all warnings and instructions for future reference.

⚠ CORDLESS HEDGE TRIMMER SAFETY WARNINGS

Keep all parts of the body away from the blade. Do not remove cut material or hold material to be cut when blades are moving. Blades continue to move after the switch is turned off. A moment of inattention while operating the hedge trimmer may result in serious personal injury.

Carry the hedge trimmer by the handle with the blade stopped and fingers away from all power switches. Proper carrying of the hedge trimmer will decrease the risk of inadvertent starting and resultant personal injury from the blades.

When transporting or storing the hedge trimmer, always fit the blade cover. Proper handling of the hedge trimmer will decrease the risk of personal injury from the blades.

Make sure all power switches are off when clearing jammed material or servicing the unit. Unexpected actuation of the hedge trimmer while clearing jammed material or servicing may result in serious personal injury.

Hold the hedge trimmer by insulated gripping surfaces only, because the blade may contact hidden wiring or its own cord. Blades contacting a "live" wire may make exposed metal parts of the hedge trimmer "live" and could give the operator an electric shock.

Keep all power cords and cables away from cutting area. Power cords or cables may be hidden in hedges or bushes and can be accidentally cut by the blade.

Do not use the hedge trimmer in bad weather conditions, especially when there is a risk of lightning. This decreases the risk of being struck by lightning.

⚠ EXTENDED-REACH HEDGE TRIMMER SAFETY WARNINGS

To reduce the risk of electrocution, never use the extended-reach hedge trimmer near any electrical power lines. Contact with or use near power lines may cause serious injury or electric shock resulting in death.

Always use two hands when operating the extended-reach hedge trimmer. Hold the extended-reach hedge trimmer with both hands to avoid loss of control.

Always use head protection when operating the extended-reach hedge trimmer overhead. Falling debris can result in serious personal injury.

ADDITIONAL SAFETY WARNINGS

Never allow children, persons with reduced physical, sensory or mental capabilities or lack of experience and knowledge or people unfamiliar with these instructions to use the machine, local regulations may restrict the age of the operator.

Clear the work area before each use. Remove all objects, such as cords, lights, wires, or strings which can be thrown or become entangled in the cutting means.

Check the hedge for foreign objects, such as wire fences. Never use the product near posts, fences, buildings, or other immovable objects.

Beware of thrown objects; keep all bystanders, children, and pets at least 15 m away from work area.

Do not operate in poor lighting. The operator requires a clear view of the work area to identify potential hazards.

Inspect the product before each use. Check for loose fasteners, etc. Make sure all guards and handles are properly and securely attached. Replace any damaged parts before use. Check for battery pack leaks.

Do not modify the product in any way.

Do not allow children or untrained individuals to use the product.

Wear full eye and hearing protection while operating the product. If working in an area where there is a risk of falling objects, wear appropriate head protection.

Secure long hair so it is above shoulder level to prevent entanglement in moving parts.

Do not use the product when you are tired, ill, or under the influence of alcohol, drugs, or medication.

Keep firm footing and balance. Do not overreach. Overreaching can result in loss of balance or exposure to hot surfaces.

Before starting the product, make sure the cutting blades will not come in contact with anything.

While operating the hedge trimmer, always hold it firmly with both hands by the two handles. Ensure that the operating position is safe and secure. The manufacturer does not recommend the use of steps or ladders. If higher trimming is required, use an extended-reach tool.

Blades are sharp. When handling the blade assembly, wear non-slip, heavy duty protective gloves. Do not place your hand or fingers between blades or in any position where they could get pinched or cut. Never touch the blade nor service the product unless the battery pack is removed.

Do not force the product through heavy shrubbery. This can cause the blades to bind and slow down. If the blades slow down, reduce the pace.

Do not attempt to cut stems or twigs that are larger than 28 mm, or those obviously too large to feed into the cutting blade.

Use a non-powered hand saw or pruning saw to trim large stems. Use of hearing protection reduces the ability to hear warnings (shouts or alarms). The operator must pay extra attention to what is going on in the working area.

⚠ WARNING! If the product is dropped, suffers heavy impact, or begins to vibrate abnormally, immediately stop the product and inspect for damage or identify the cause of the vibration. Any damage should be properly repaired or replaced by an authorised service centre.

Remove the battery pack before starting any work on the machine.

Do not dispose of used battery packs in the household refuse or by burning them. Milwaukee Distributors offer to retrieve old batteries to protect our environment.

Do not store the battery pack together with metal objects (short circuit risk).

Use only System M18 chargers for charging System M18 battery packs. Do not use battery packs from other systems.

Battery acid may leak from damaged batteries under extreme load or extreme temperatures. In case of contact with battery acid wash it off immediately with soap and water. In case of eye contact rinse thoroughly for at least 10 minutes and immediately seek medical attention.

Warning! To reduce the risk of fire, personal injury, and product damage due to a short circuit, never immerse your tool, battery pack or charger in fluid or allow a fluid to flow

inside them. Corrosive or conductive fluids, such as seawater, certain industrial chemicals, and bleach or bleach containing products, etc., can cause a short circuit.

TRANSPORTATION AND STORAGE

Stop the product, remove the battery, and allow it to cool before storing or transporting.

Clean all foreign materials from the product. Store the product in a cool, dry, and well-ventilated place that is inaccessible to children. Keep away from corrosive agents, such as garden chemicals and de-icing salts. Do not store outdoors.

For transportation in vehicles, secure the product against movement or falling to prevent injury to persons or damage to the product.

TRANSPORTING LITHIUM BATTERIES

Lithium-ion batteries are subject to the Dangerous Goods Legislation requirements.

Transportation of those batteries has to be done in accordance with local, national and international provisions and regulations.

- The user can transport the batteries by road without further requirements.
- Commercial transport of Lithium-Ion batteries by third parties is subject to Dangerous Goods regulations. Transport preparation and transport are exclusively to be carried out by appropriately trained persons and the process has to be accompanied by corresponding experts.

When transporting batteries:

- Ensure that battery contact terminals are protected and insulated to prevent short circuit.
- Ensure that battery pack is secured against movement within packaging.
- Do not transport batteries that are cracked or leak.

Check with forwarding company for further advice

RESIDUAL RISK

Even when the product is used as prescribed, it is still impossible to completely eliminate certain residual risk factors. The following hazards may arise in use and the operator should pay special attention to avoid the following:

- Injury caused by contact with the blades. Contact with the blades can cause serious injury. Keep the blade away from yourself and others. Cover it with the blade protector whenever you are not cutting.
- Injury caused by vibration. Hold the product by designated handles and restrict working time and exposure.
- Exposure to noise can cause hearing injury. Wear ear protection and limit exposure.
- Injury due to flying debris. Wear eye protection, heavy long trousers, gloves and substantial footwear at all times.

SPECIFIED CONDITIONS OF USE

The cordless hedge trimmer is only intended for use outdoors. For safety reasons the product must be adequately controlled by using two-handed operation.

The product is designed for home or domestic use. It is intended to cut and trim hedges, shrubs, and similar vegetation.

It should be used in dry, well-illuminated conditions.

It is not intended to cut grass, trees, or branches. It should not be used for any other purpose than hedge trimming.

Do not use this product in any other way as stated for normal use.

EC-DECLARATION OF CONFORMITY

We declare under our sole responsibility that the product described under "Technical Data" fulfills all the relevant provisions of the directives 2011/65/EU (RoHS), 2014/30/EU, 2006/42/EC, 2000/14/EC, 2005/88/EC and the following standards have been used:

EN 60745-1:2009+A11:2010
EN 60745-2-15:2010+A1:2010
EN 55014-1:2017
EN 55014-2:2015
EN ISO 3744:2010
EN 50581:2012

Measured sound power level: ?? dB(A)
Guaranteed sound power level: ?? dB(A).

Winnenden, 2018-11-05

Alexander Krug
Managing Director



Authorized to compile the technical file.

Techtronic Industries GmbH
Max-Eyth-Straße 10
71364 Winnenden
Germany

BATTERIES

Battery packs which have not been used for some time should be recharged before use.

Temperatures in excess of 50°C (122°F) reduce the performance of the battery pack. Avoid extended exposure to heat or sunshine (risk of overheating).

The contacts of chargers and battery packs must be kept clean.

For an optimum life-time, after use, the battery packs have to be fully charged.

To obtain the longest possible battery life remove the battery pack from the charger once it is fully charged.

For battery pack storage longer than 30 days:
Store the battery pack where the temperature is below 27°C and away from moisture
Store the battery packs in a 30% - 50% charged condition
Every six months of storage, charge the pack as normal.

MAINTENANCE

After each use, clean the body and handles of the product with a soft, dry cloth.

After each use, clean the debris from the blades with a stiff brush, and then carefully apply a rust preventative lubricant before refitting the blade protector. The manufacturer recommends you to use a rust preventative and lubricant spray to apply an even distribution and reduce the risk of personal injury from contact with the blades. For information about suitable spray product, please contact one of our Milwaukee service agents (see our list of guarantee/service addresses).

You may wish to lubricate the blades lightly before use if necessary using the above method.









Keep all nuts, bolts and screws tight to be sure that the machine is in safe working condition.















Examine the machine and replace worn or damaged parts for safety.

Use only Milwaukee accessories and Milwaukee spare parts. Should components need to be replaced which have not been described, please contact one of our Milwaukee service agents (see our list of guarantee/service addresses).

If needed, an exploded view of the tool can be ordered. Please state the machine type printed as well as the six-digit No. on the label and order the drawing at your local service agents or directly at: Techtronic Industries GmbH, Max-Eyth-Straße 10, 71364 Winnenden, Germany.

SYMBOLS

	CAUTION! WARNING! DANGER!
	Please read the instructions carefully before starting the machine.
	Remove the battery pack before starting any work on the machine.
	Always wear goggles when using the machine.
	Wear ear protectors!
	Wear non-slip, heavy duty gloves
	Wear head protection
	DANGER – Keep sufficient distance away from electrical power lines.

	Keep bystanders a safe distance away from the machine.
	
	Always hold the hedge trimmer with both hands when operating.
	To prevent serious injury, do not touch cutting blades.
	Do not use in the rain or leave outdoors while it is raining.
	The guaranteed sound power level is 93 dB.
	
	No Load Strokes per Minute (SPM)
	Do not dispose electric tools, batteries/rechargeable batteries together with household waste material. Electric tools and batteries that have reached the end of their life must be collected separately and returned to an environmentally compatible recycling facility. Check with your local authority or retailer for recycling advice and collection point.
	Stroke rate under no-load
	Volts
	Direct current
	European Conformity Mark
	Ukraine Conformity Mark
	EurAsian Conformity Mark

Copyright 2018
Techtronic Industries GmbH
Max-Eyth-Straße 10
71364 Winnenden
Germany
+49 (0) 7195-12-0



(11.18)

4931 4701 82