









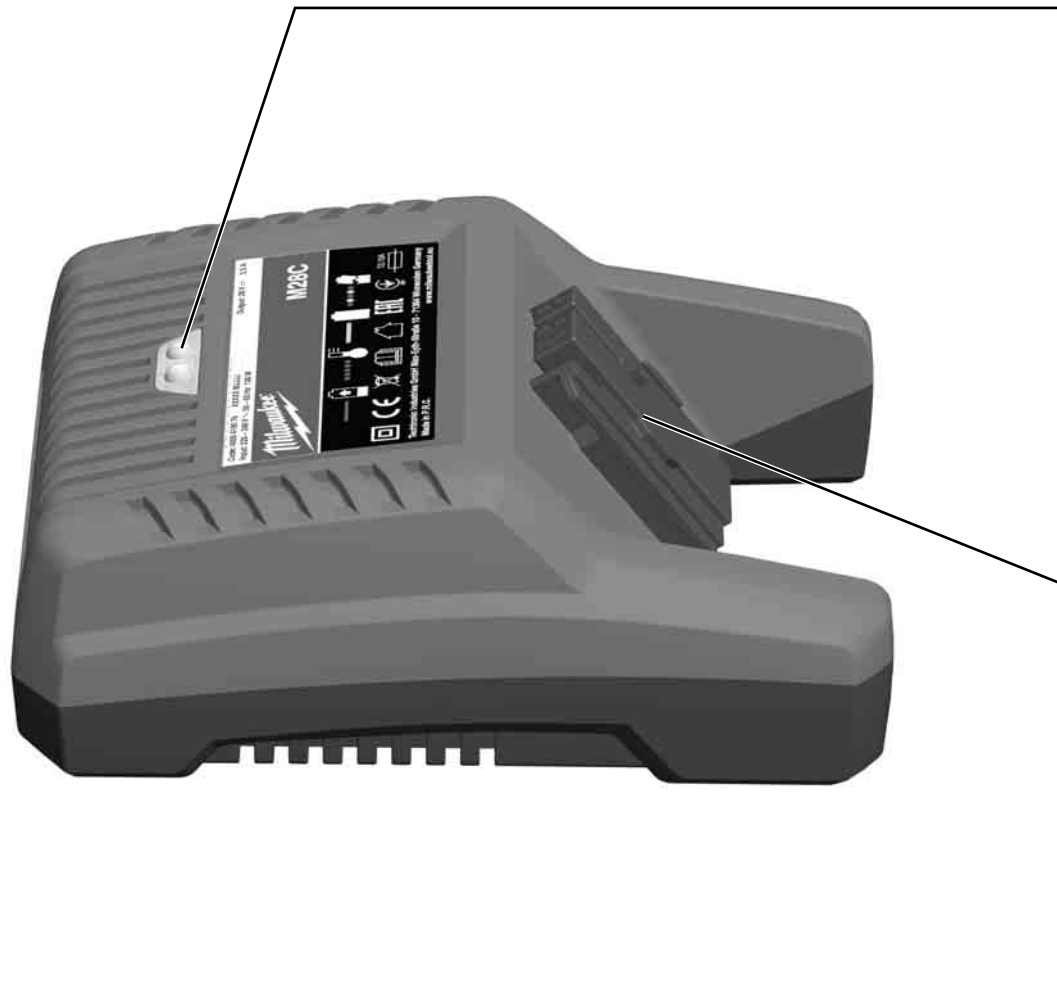

Nothing but **HEAVY DUTY.**[®]

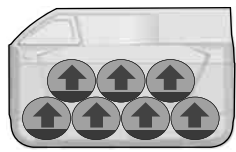
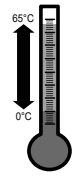

M28 C

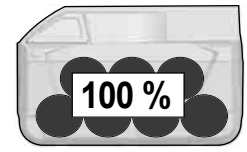
Original instructions

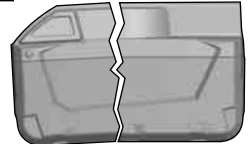

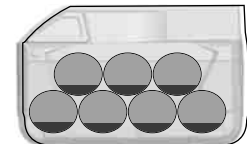
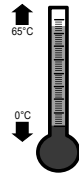
| | | |
|--|--|--|
|  RED |  |  |
|  GREEN |  | |
|  RED/GREEN ■■■■■ |  | |
|  RED ■■■■■ |  |  |

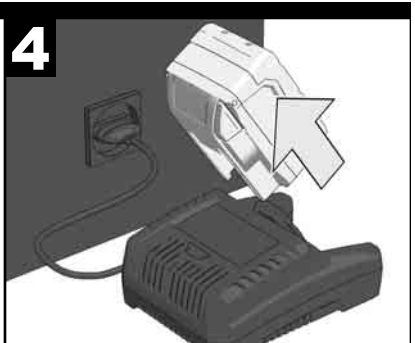
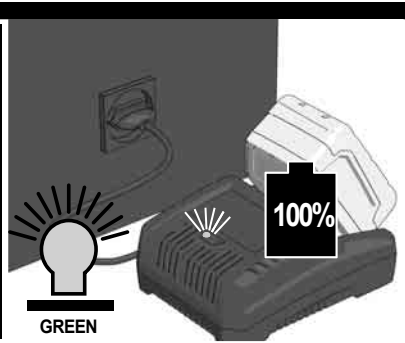
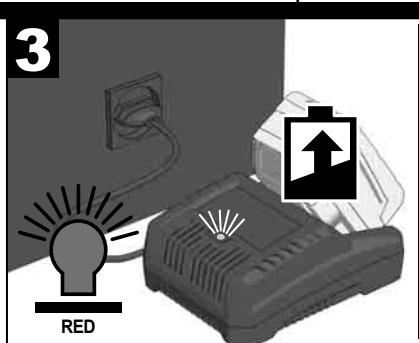
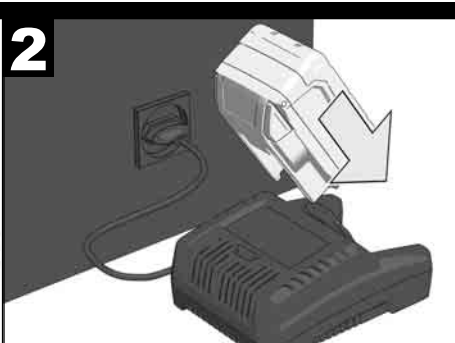
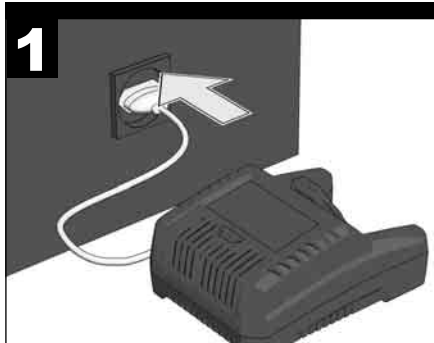

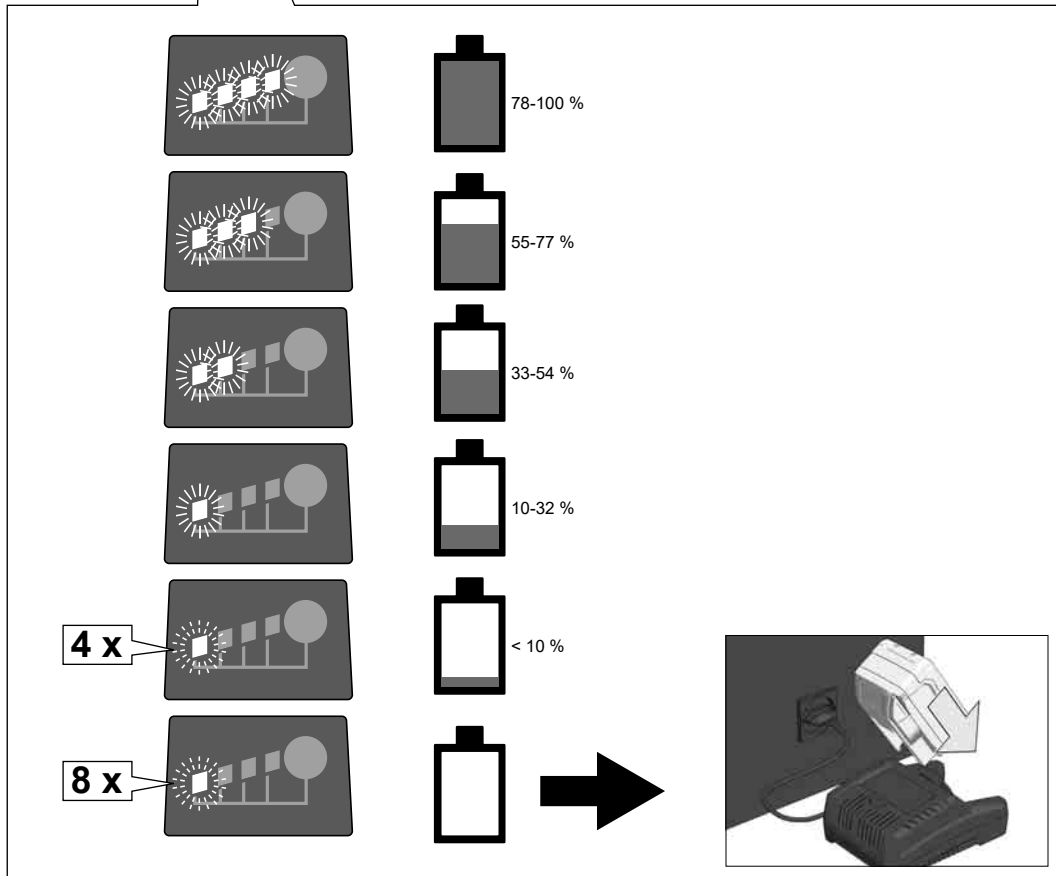
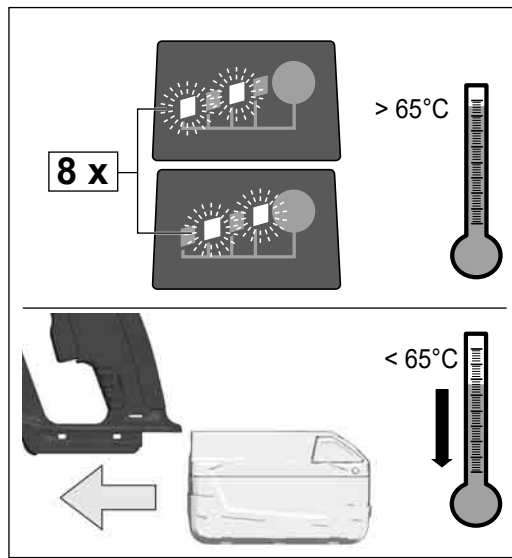
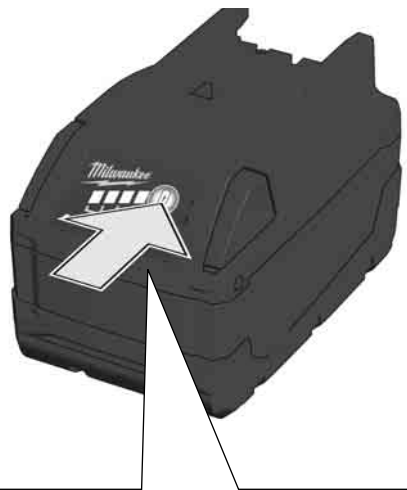

TECHNICAL DATA BATTERY CHARGER

| | |
|--|-------------|
| Voltage range | 28 V |
| Quick charge current | 3.5 A |
| Battery charging time | approx. 1 h |
| Weight according EPTA-Procedure 01/2014 | 700 g |
| Recommended ambient charging temperature | +5...+40 °C |

WARNING! Read all safety warnings and all instructions. Failure to follow the warnings and instructions may result in electric shock, fire and/or serious injury. Save all warnings and instructions for future reference.

SAFETY INSTRUCTIONS

Do not dispose of used battery packs in the household refuse or by burning them. Milwaukee Distributors offer to retrieve old batteries to protect our environment.

Only the following battery packs can be charged with this charger:

| Battery Cat. No. | Cell Type | DC Volts | Capacity | Cell No. |
|------------------|-----------|----------|----------|----------|
| M28 BX | Li-Ion | 28 V | ≤ 3.0 Ah | 2 x 7 |
| M28 B5 | Li-Ion | 28 V | ≤ 5.0 Ah | 2 x 7 |

Do not try to charge non-rechargeable batteries with this charger.

Do not store the battery pack together with metal objects (short circuit risk).

No metal parts must be allowed to enter the battery section of the charger (short circuit risk).

Never break open battery packs or chargers and store only in dry rooms. Keep dry at all times.

The battery clamps of the charger are fed by the mains supply. Do not touch the tool with conducting objects.

Never charge a damaged battery pack. Replace by a new one.

Before use check machine, cable, and plug for any damages or material fatigue. Repairs should only be carried out by authorised Service Agents.

This appliance is not intended to be used or cleaned by persons with reduced physical, sensory or mental capabilities, or lack of experience or knowledge, unless they have been given instructions concerning the safe use of the appliance by a person legally responsible for their safety. They should be supervised whilst using the appliance. Children shall not use, clean or play with this appliance, which when not in use should be secured out of their reach.

Warning! To reduce the risk of fire, personal injury, and product damage due to a short circuit, never immerse your tool, battery pack or charger in fluid or al-low a fluid to flow

inside them. Corrosive or conductive fluids, such as seawater, certain industrial chemicals, and bleach or bleach containing products, etc., Can cause a short circuit.

SPECIFIED CONDITIONS OF USE

The quick charger can charge Milwaukee M28 Li-Ion batteries System M28 and V28 Li-Ion batteries System V28.

Do not use this product in any other way as stated for normal use.

MAINS CONNECTION

Connect only to single-phase a.c. current and only to the system voltage indicated on the rating plate. It is also possible to connect to sockets without an earthing contact as the design conforms to safety class II.

LI-ION BATTERIES

The rechargeable batteries are partially charged and supplied in a non-operative state. Prior to initial use it is necessary to activate the battery by plugging it into the charger briefly. The LED on the battery indicates the state of charge.

If it is not used for long periods, the rechargeable battery will switch to the non-operative state and needs to be reactivated before reuse.

The state of charge can be read by pressing the button on the rechargeable battery. The battery can be left in the electric tool while the reading is taken but it must be switched off at least one minute beforehand (otherwise the display will be inaccurate). The number of LEDs illuminated indicates the state of charge.

As a general principle, if the electric tool should fail to work after inserting the rechargeable battery, then the battery should be plugged into the charger. The displays on the battery and charger will then provide information about the condition of the battery.

In low temperatures work may continue at reduced output.

For an optimum life-time, after use, the battery packs have to be fully charged.

For battery pack storage longer than 30 days: Store the battery pack where the temperature is below 27°C and away from moisture Store the battery packs in a 30% - 50% charged condition Every six months of storage, charge the pack as normal.

To obtain the longest possible battery life remove the battery pack from the charger once it is fully charged.

CHARACTERISTICS

After inserting the battery into the reception of the charger the battery will automatically be charged (red control lamp is illuminated continuously)

When a hot or cold battery pack is inserted into the charger (flashing red lamp), charging will begin automatically once the battery reaches the correct charging temperature (0°C...65°C). The max. charging current is flowing when the temperature of the Li-Ion-battery is between 0°C and 65°C.

The battery's charging time is between 1 min and 60 min (at 3,0 Ah), depending on the state of discharge.

Once the battery is fully charged, the LED on the charger changes from red to green.

It is not necessary to remove the battery after charging. The battery can be stored permanently in the charger without the danger of being overcharged.

If both LEDs flash alternately then the rechargeable battery is either not fully pushed in or there is a fault with the battery or charger. Take the charger and battery out of use immediately for safety reasons and have them inspected by a Milwaukee customer service centre.

All LED will flash 4x if the machine is overloaded. To continue working, switch the machine off and then on again.

TRANSPORTING LITHIUM BATTERIES

Lithium-ion batteries are subject to the Dangerous Goods Legislation requirements.

Transportation of those batteries has to be done in accordance with local, national and international provisions and regulations.

- The user can transport the batteries by road without further requirements.
- Commercial transport of Lithium-Ion batteries by third parties is subject to Dangerous Goods regulations. Transport preparation and transport are exclusively to be carried out by appropriately trained persons and the process has to be accompanied by corresponding experts.

When transporting batteries:

- Ensure that battery contact terminals are protected and insulated to prevent short circuit.
- Ensure that battery pack is secured against movement within packaging.
- Do not transport batteries that are cracked or leak.

Check with forwarding company for further advice

MAINTENANCE

If the supply cord of this appliance is damaged, it must only be replaced by a repair shop appointed by the manufacturer, because special purpose tools are required

Use only Milwaukee accessories and Milwaukee spare parts. Should components need to be replaced which have not been described, please contact one of our Milwaukee service agents (see our list of guarantee/service addresses).

If needed, an exploded view of the tool can be ordered. Please state the Article No. as well as the machine type printed on the label and order the drawing at your local service agents or directly at: Techtronic Industries GmbH, Max-Eyth-Straße 10, 71364 Winnenden, Germany.

SYMBOLS



Please read the instructions carefully before starting the machine.



Do not burn used battery packs.



Never charge a damaged battery pack. Replace with a new one.



Do not dispose electric tools, batteries/ rechargeable batteries together with household waste material. Electric tools and batteries that have reached the end of their life must be collected separately and returned to an environmentally compatible recycling facility. Check with your local authority or retailer for recycling advice and collection point.



This tool is only suitable for indoor use. Never expose tool to rain.



Time-lag fuse 3.15 A



Double isolated



European Conformity Mark



British Conformity Mark



Ukraine Conformity Mark



EurAsian Conformity Mark

Copyright 2021

Techtronic Industries GmbH
Max-Eyth-Str. 10
71364 Winnenden
Germany

+49 (0) 7195-12-0

www.milwaukeeetool.eu

Techtronic Industries (UK) Ltd
Fieldhouse Lane
Marlow Bucks SL7 1HZ
UK



**EAC UK
CA**

(03.21)

4100 4146 78