

Fig. 4



Fig. 5

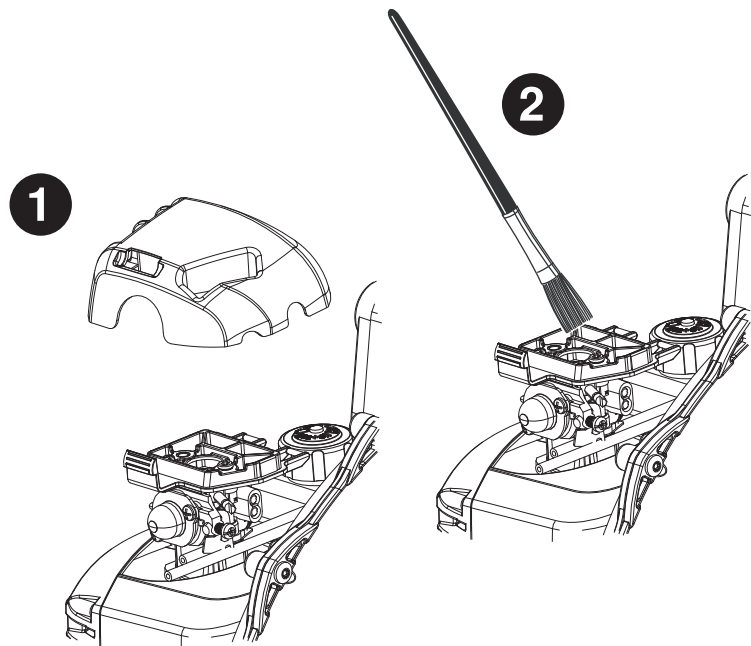

Fig. 6

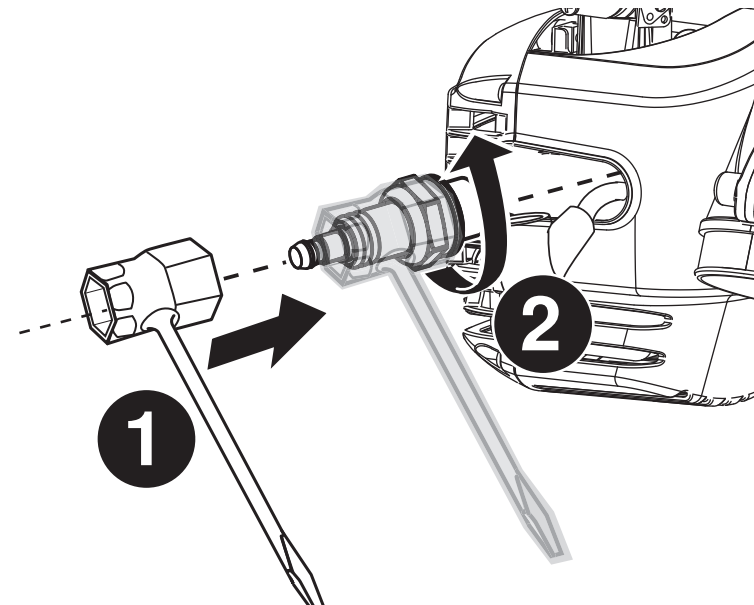

Fig. 7